

Article number: 03221020

Description: Fluro Rod End GALRSW 20-R

Housing and ball in stainless steel with left-handed thread

## Measures

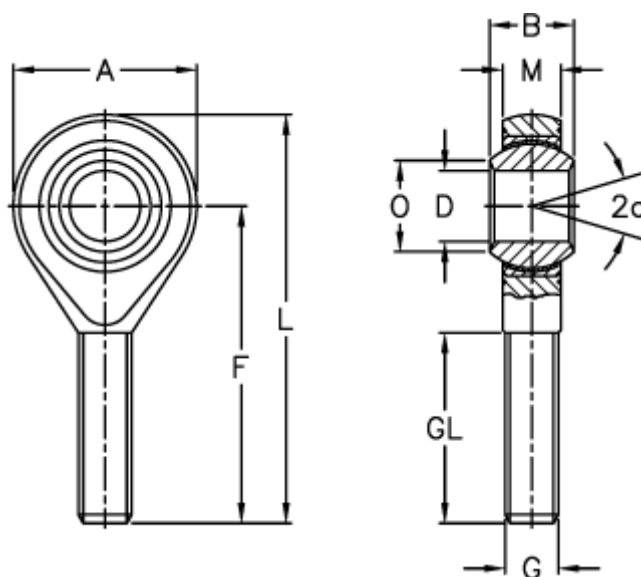

A	= 50	L	= 103
a (degrees)	= 14	M	= 18
B	= 25	O	= 24.3
D	= 20	Permissible rpm	= 190
Dynamic load C (kN)	= 78	Static load C0 (kN)	= 83
F	= 78	Weight (g)	= 348
g	= M20x1,5		
GL	= 47		